

Filterlüfter
Filter Fan **LV 410-EC**



Technische Daten / Technical data:		
Type:	LV 410-EC	
Spannung Voltage	230 V 50/60 Hz	
Stromaufnahme Amperage	0,19 A	
Leistung Power input	24 W	
Drehzahl Speed	2800/3200 min ⁻¹	
Temperaturbereich Temperature range	-20...+70°C	
Lebensdauer Service life	40.000	
Zulassung Approval	UL, CE	
Farben colours	RAL 7035 (Standard), RAL 7032	
Schutzart Degree of protection	IP 54 mit Filtermatte G3 IP 54 with Filter mat G3	
	IP 55 mit Z-Line Filter (M5) und Streckmetall, UV-beständiges Frontgitter IP 55 with Z-Line Filter (M5) and expanded metal, UV-resistant front grille	
Dichtung Gasket	aufgeschäumte Dichtung foamed gasket	
Luftfördermenge / Air flow: (m³/h)		
Filtermatte Filter mat	G3 min.Drehzahl	G3 max.Drehzahl
Luftleistung freiblasend Air flow free air	240	280
mit Austrittsfilter GV 400/500 with exhaust filter	190	228
mit 2 x GV 400/500 with 2 exhaust filter	220	255

Zubehör / Accessories:

Austrittsfilter / Exhaust filter
Ersatzfiltermatte / Replacement filter mat
Thermostate / Thermostats

GV 400/500
AM 435P, AM 400P, AM 400T, ZF 400/500
TRS 60, TRW 60, TWR 60, TKW 60

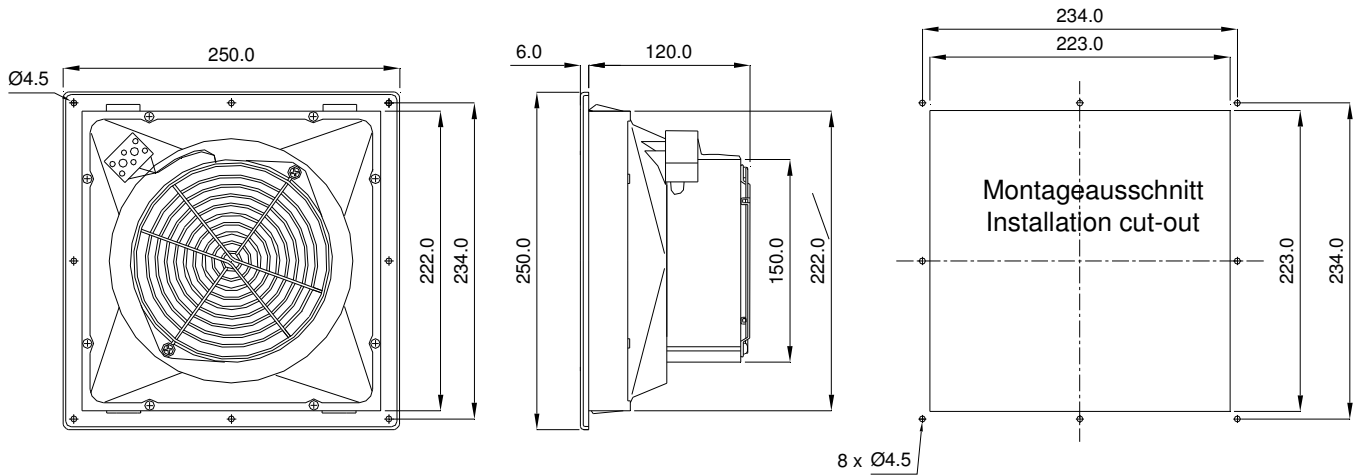

Bohrungen nur bei
Schraubbefestigung

Drill-holes are only necessary if fan
is to be fastened with screws

Leistungsdiagramm Performance diagram

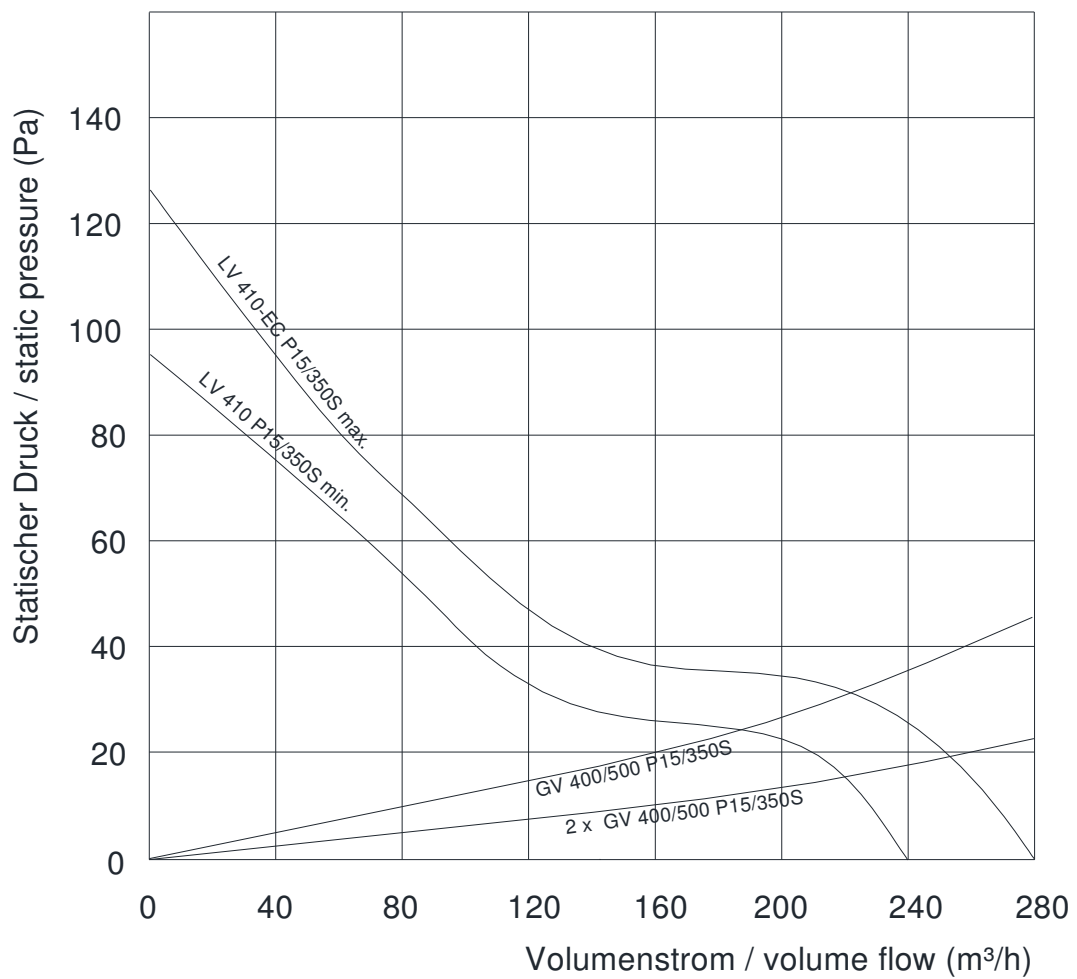

Rev. 12/15

